

Operating Instructions COP-N-110

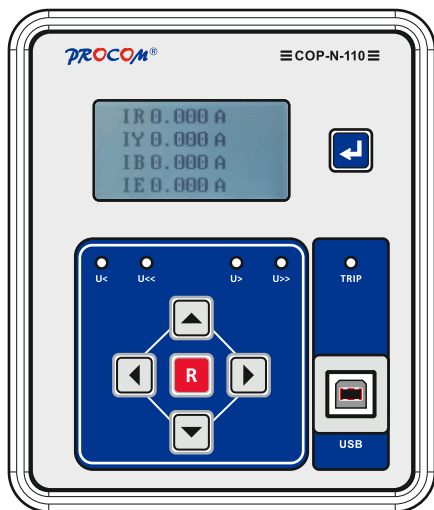

INDEX

- 1.0 Introduction :**
- 2.0 Protection, Supervision Salient Features :**
- 3.0 Digital Output :**
- 4.0 Display Parameter :**
- 5.0 Digital Input :**
- 6.0 Protection :**
- 7.0 Switches Description :**
- 8.0 LED Annunciations :**
- 9.0 Display Measurement :**
- 10.0 Setting Procedure :**
- 11.0 Connection Diagram / Terminal arrangement :**
- 12.0 Technical specification :**
- 13.0 Dimensional Details :**

1.0 Introduction :

- The COP is Designed Using Numerical Technology (Discrete Fast Fourier Transformation.) Reliable & Accurate Tripping is Ensured by Deploying Digital Technique Using DSP. High Sampling Rate of 2000 Sample/Sec Ensures Actual Reproduction of Waveform.
- User Friendly HMI Eases Configuration & Operating procedure of Relay
- User Programmable Digital Output provides flexibility in Selecting Alarm Contact.
- In Addition to Default USB Part one Optional RS-485 Port is also Provided.
- Wide Auxiliary Supply(60-300 VDC/50-300VAC)
- All Protections can be programmed to be individually or collectively blocked by external input

2.0 Protection, Supervision Salient Features :

- 128x64 Pixel Graphical /display
- Event Recording
- Fault Data Recording
- RTC Stamp on Fault & Event
- Display in Primary/Secondary Values
- Wide Setting range with fine setting steps
- Front USB Port
- RS-485 communication Port with MODBUS protocol
- Self Supervision
- Remote Reset input

3.0 Digital Output :

COP-N had upto 4 NO Contact. one is reserved for tripping function.
3 are programmable for alarm function.

- Alarm 1 (NO Contact)
- Alarm 2 (NO Contact)
- Alarm 3 (NO Contact)
- Trip 1 (NO/NC Contact)

4.0 Display Parameter :

- Voltage
- Date
- Time

5.0 Digital Input :

COP-N had up to 6 digital input.

- **Blocking Input** : Protection function can be blocked either by programming or using external blocking input. There are 4 blocking input and each protection function **U>**, **U>>**, **U<**, **U<<** , can be assigned to set of the input.
- **Trip**: The external trip input can be used to trip the unit.
- **Reset**: The trip indication can be reset either Auto or Manually.
If the **Trip Reset** function are programmed as **Auto** in system parameter then the trip contact & trip indication will reset automatically after clearance of fault.
If the **Trip Reset** function are programmed as **Manual** in system parameter then the trip contact will reset automatically after clearance of fault but trip indication will reset either pressing the reset key on the front or external reset input shorted to the common.





6.0 Protection :



- Over Voltage Protection
- High set Over Voltage Protection
- Under Voltage Protection
- High set Under Voltage Protection

7.0 Switches Description :

The function of relay is controlled by the following switches. Back Switch, Next Switch, Up Switch, Down Switch, Enter key, Reset Key and Test Key which are provided on the front plate.

COP-N has a very sophisticated HMI build into it. These keys play different role under different function of HMI

Switch Symbol	Switch Function	Description
	Back Switch and Next Switch	To enter Edit/View Mode the Back Switch and Next Switch are pressed together.
	Back Switch	This key has dual function. Programming Main Menu : Back key is used to exit programming main menu & go to the display default mode. Programming Sub Menu : Back key is used to select the previous parameter to be programmed.
	Next Switch	This key has dual function. Normal operation mode : In this mode, it is used to change the parameters being displayed on LCD. Programming Sub Menu : Next key is used to select next parameter in programming sub menu.
	UP Switch	This key has dual function. Programming Main Menu : Up key is used to scroll the programming modes in programming main menu. Programming Sub Menu : Up key is used to increment the value of parameters in programming sub menu.
	Down switch	This key has dual function. Programming Main Menu : Down key is used to scroll the programming modes in programming main menu. Programming Sub Menu : Down key is used to decrement the value of parameter in programming sub menu.

	Enter Switch	<p>This key has dual function.</p> <p>Programming Main Menu: Enter key is used to select the programming modes in programming main menu.</p> <p>Programming Sub Menu : Enter key is used to save the parameter in programming sub menu.</p>
	Reset Switch	Reset key is used to reset the fault/annunciations. & also used to discard the saving parameter while doing the settings and abort to main menu.

Note: At the time of setting if changes are not carried within 20s then the display will reset itself and return to the main menu.

8.0 LED Annunciations :

S.No	LED's	Description
1	v>	This led indicates an low set over voltage fault
2	v<	This led indicates an low set under voltage fault.
3	v>>	This led indicates an high set over voltage fault
4	v<<	This led indicates an high set under voltage fault.
5	Trip	Indicates fault occurrence

9.0 Display Measurement :

Graphical back-lit LCD Display is provided for parameter setting and for easy viewing of measurement, fault, event records, date and time, error message. Back-lit is automatically turned ON when any tripping occurs on particular equipment.

After Power ON , it will show the following display :

A light green rectangular box containing the text "VER".

VER

This window will flash momentarily showing the following display. Then the control will go automatically to next window which is shown below :

A light green rectangular box containing three lines of text: "VRY 0.0 %", "VYB 0.0 %", and "VBR 0.0 %".

VRY 0.0 %
VYB 0.0 %
VBR 0.0 %

It will display the phase to phase voltage in % of rated voltage. After 10 sec the display will automatically scroll to next display window or press **Next** key can be used to manually switch to next window.

A light green rectangular box containing three lines of text: "VR 0.0 %", "VY 0.0 %", and "VB 0.0 %".

VR 0.0 %
VY 0.0 %
VB 0.0 %

It will display the line to neutral voltage in % of rated voltage. After 10 sec the display will automatically scroll to next display window or press **Next** key can be used to manually switch to next window.

A light green rectangular box containing a clock icon, the time "20:48:10", and the date "18:07:2014".

20:48:10
18:07:2014

This will the display the time and date.

10.0 Setting Procedure :

COP-N has provision to program the operating parameters. It is user / site configurable. User can view all parameters, fault history, events, adjust clock, reset password and also edit the parameter.

Press “Back Switch & Next Switch” simultaneously.

The LCD shall display, “**Programming Main Menu**”

This menu has a various programming modes which is scroll by **Up** and **Down** key.

Edit programming mode is password protected.

To select the programming mode in programming main menu, press **Enter** key.

The LCD display, “**Enter Password**”. The default password is 1 which is set by **UP & Down** key then press **Enter** key.

Programming Main Menu

E SYSTEM PARA
E PARAMETER
E BLOCKING
E ANNUNCIATION
SET CLOCK
RESET PASS

V SYSTEM PARA
V PARAMETER
V BLOCKING
V ANNUNCIATION
V HISTORY
V EVENT

E SYSTEM PARA :

For any change in value, press Up switch and Down switch. For next parameter, press Next Switch. We can also view the previous parameter by pressing Back Switch. To save the parameter, press Enter key.

Display	Explanation of Parameter	Factory Setting	Setting Range	Setting Step
PT Ratio	Ratio of potential transformer, (Rated PT Primary voltage/ Rated PT Secondary voltage)	1	1-2000	1
I/P Connection	Voltage connection to the controller is selectable	230V -3P4W	110V - 1Ph 110V - 2Ph 110V - 3Ph 230V - 3P4W 400V - 3P-3W	
Test Function	For testing the unit, press the test key if this function is enabled.	Disabled	Enabled disabled	
Disp Auto Scroll	Measurement display auto scroll or manual scroll selection	Auto Scroll OFF	Auto Scroll On Auto Scroll off	
Dis V in Pri/Sec	Selection of voltage display in primary values or secondary values	Primary	Primary Secondary	
Flag Reset	Reset for flag indication.	Auto	Auto Manual	
Trip Reset	Reset for tripped LED indication	Auto	Auto Manual	

E PARAMETER:

For any change in value of parameter, press Up switch and Down switch. For next parameter, press Next Switch. We can also view the previous parameter by pressing Back Switch. To save the parameter press, Enter key.

UV< in V/Vn	Under Voltage low set value in % of rated voltage	0.80	0.40-1.00 V/Vn Disable	0.01 V/Vn
UV< Def Time	Definite time delay in seconds.	1.0 Sec	0.03-20.00 Sec	0.01 Sec
UV< Trip	If Enabled then only UV< fault occurs	disabled	Enabled disabled	
UV<< in V/Vn	Under Voltage high set value in % of rated voltage.	0.60	0.40-1.00 V/Vn Disable	0.01 V/Vn
UV<< Def Time	Definite time delay in seconds.	0.10	0.01-20.00 Sec	0.01 Sec
OV> in V/Vn	Over Voltage low set value in % of rated Voltage.	1.10	0.80-1.70 V/Vn Disable	0.01 V/Vn
OV> Def Time	Definite time delay in seconds.	1.0 Sec	0.01-20.00 Sec	0.01 Sec
OV> Trip	If Enabled then only OV> fault occurs	disabled	Enabled disabled	
OV>> in V/Vn	Over Voltage high set value in % of rated Voltage	1.20	0.80-1.70 V/Vn Disable	0.01 V/Vn
OV >> Def Time	Definite time delay in seconds.	0.10	0.01-20.00 Sec	0.01 Sec
Voltage Hys	Voltage hysteresis for resetting under/over voltage.	3%	1-25%	1%
Power on UV Pick	After UV Healthy: under voltage function will be activated if voltage once crosses 50% of voltage UV Monitor P-ON: under voltage function will be activated as soon as the unit is power on.	After UV Healthy	After UV Healthy UV Monitor P-ON	
All voltage fail	To prevent fault if all voltage fail together	disabled	Enabled disabled	

Relay Standards

Title	Standard No.
Electromagnetic Compatibility Type Test:	
High Frequency Test	: IEC 60255-22-1, class – III : Frequency : 1MHz Damped Oscillatory : Longitudinal :5 KV (peak) : Duration: sec duration 2 sec. : Between input current Terminal
Electrostatic Discharge Direct Application	: IEC 60255-22-2 Class III and IEC 61000-4-2 class III. : Contact discharge: 6kV, : Air discharge: 8KV : Polarity: both +ve and –Ve polarities.
Indirect Application	: IEC-61000-4-2, Class-III
Fast Transient Disturbance	: IEC 60255-22-4 and IEC 61000-4-4, class A : 1.2KV; 5/50ns; 5KHz burst duration = 15ms. : Repetition rate 300ms; Both polarities; Ri = 50W; duration 1 min.
Surge Immunity Test	: IEC 60255-22-5 / IEC 61000-4-6 class 4 : Differential Mode = 2kV : Common Mode = 4kV : 1.2/50uS , 5 surges of each polarity
Power Frequency Magnetic Field Test	: IEC-61000-4-8, Class-V
Radiated Electromagnetic Field Disturbance	: IEC- 60255-22-3 : EN-61000-4-3 : Frequency 80MHz – 1GHz
Conducted Disturbance Induced By Radio Frequency Field	: IEC 60255-22-6 / IEC 61000-4-6: 1996. : Freq. 150kHz – 80MHz, Amplitude 10 V, Modulation 80% AM @ 1 KHz
AC Ripple In DC Supply Test	: IEC 60255-11
Radiated Emission	: IEC 60255-25
Insulation Tests:	
High Voltage Test	: IEC 60255-5. class – III : At 2.5kV 50Hz between all terminal connected together and earth for 1 minutes

Impulse Voltage Test	: IEC 60255-5. class – III : Test voltage: 5KV (peak) 1.2 / 50us, : Energy :0.5 J, : Polarity : + ve and – Ve : Nos. of impulses : 3 positive and 3 negative impulse : Duration between Impulses : 5 sec.
Insulation Tests:	
Cold test Storage test	: IEC 60068-2-1
Dry heat test	: IEC 60068-2-2
Damp heat test, steady state	: IEC 60068-2-3
Damp heat test, cyclic	: IEC 60068-2-30
Mechanical tests	
Vibration	IEC 60255-21-1 class 1 Frequency Range = 10Hz – 150Hz , acceleration. 1gn (9.8m/s ²) : Sweep rate 1 octave/min; 20 cycle in 3 orthogonal axis.
Bump Test	: IEC 60255-21-2 Class-1 : 1000 bumps of 10gn peak acceleration and 16ms pulse duration in each of the two opposite direction per axis as per IEC 60255-21-2 class 1 No. of axes . 3.
Shock Withstand	: IEC 60255-21-2 Clas-1 : 3 shocks of 15gn peak acceleration and 11ms pulse in each of two opposite direction . No. of axis : 3
Seismic Test	: IEC 60255-21-3 : In single axis sine sweep in X-axis sweep (@a sweep rate of 1 octave/minute) vibration in the frequency range (5-40 Hz) at amplitude of 3.5mm or 1.0gn (whichever is less) : In single axis sine sweep in Y-axis - sweep (@a sweep rate of 1 octave/minute) vibration in the frequency range (5-40 Hz) at amplitude of 1.5mm or 0.5gn (whichever is less)

E BLOCKING :

For any change in value, press **Up** switch and **Down** switch.

For next parameter, press **Next** Switch. We can also edit the previous parameter by pressing **Back** Switch. To save the parameter press, **Enter** key.

Display	Explanation of Parameter	Factory Setting	Setting Range
Block U>	Low set over voltage protection is blocked if assigned blocking input is shorted to common.	Not Blocked	Not Blocked Block input 1 Block input 2 Block input 3 Block input 4
Block U>>	High set over voltage protection is blocked if assigned blocking input is shorted to common.	Not Blocked	Not Blocked Block input 1 Block input 2 Block input 3 Block input 4
Block U<	Low set under voltage protection is blocked if assigned blocking input is shorted to common.	Not Blocked	Not Blocked Block input 1 Block input 2 Block input 3 Block input 4
Block U<<	High set under voltage protection is blocked by activating the Block input 1/2/3/4.	Not Blocked	Not Blocked Block input 1 Block input 2 Block input 3 Block input 4

E ANNUNCIATION :

For any change in value, press **Up** switch and **Down** switch.

For next parameter, press **Next** Switch. We can also view the previous parameter by pressing **Back** Switch. To save the parameter press, **Enter** key.

Display	Explanation of Parameter	Factory Setting	Setting Range
Announce V>	The over voltage fault will announce on selected contact.	Not Ann	A1/A2/A3/A4/ Not Ann Contact
Announce V>>	The high set over voltage fault will announce on selected contact.	Not Ann	A1/A2/A3/A4/ Not Ann Contact
Announce V<	The under voltage fault will announce on selected contact.	Not Ann	A1/A2/A3/A4/ Not Ann Contact
Announce V<<	The low set under voltage fault will announce on selected contact.	Not Ann	A1/A2/A3/A4/ Not Ann Contact

SET CLOCK :

To change the date & time, enter the 'SET CLOCK' mode in programming main menu by pressing Enter key.

LCD Shall display :

DD:MM:YYYY

To set the date by pressing Up & Down key. Once the date set, press the Next switch

LCD Shall display :

DD:MM:YYYY

To set month by pressing Up & Down key. Once the month set, press the Next switch

LCD Shall display :

DD:MM:YYYY

To set the year by pressing Up & Down key. Once the year set, press the Next switch

LCD Shall display :

HH:MM:SS

To set the hour by pressing Up & Down key. Once the hour set, press the Next switch

LCD Shall display :

HH:MM:SS

To set minute by pressing Up & Down key. Once the minute set, press the Next switch

LCD Shall display :

HH:MM:SS

To set the Second by pressing Up & Down key.

Press the Enter key to save the date and time.

RESET PASS :

To reset the password, enter the 'RESET PASS' mode in programming main menu by pressing Enter key

The display will show as :

Enter password

0

Enter the current password by using the up arrow key and down arrow key.

Press enter key.

The display will show as :

Change password

1

Enter the new password wh by using the up arrow key and down arrow key.

Press enter key.

The display will show as :

Press

Inc to change

Dec to ESC

Press increment key If user want to change the password otherwise press decrement key.

The display will show as :

Password Updated

V SYSTEM PARA :

To view the system parameter, enter the '**V SYSTEM PARA**' mode in programming main menu by pressing **Enter** key.

This mode is not password protected. In this mode, user can only view the setting of system parameter by pressing **Next** key & **Back** key. NO change in setting is allowed here. To exit this mode, press **Reset** key.

V PARAMETER :

To view the parameter set 1, enter the '**V PARA SET 1**' mode in programming main menu by pressing **Enter** key.

This mode is not password protected. In this mode, user can only view the setting of parameter set 1 by pressing **Next** key & **Back** key. NO change in setting is allowed here. To exit this mode, press **Reset** key.

V BLOCKING :

To view the blocking parameter, enter the '**V BLOCKING**' mode in programming main menu by pressing **Enter** key.

This mode is not password protected. In this mode, user can only view the setting of blocking parameter by pressing **Next** key & **Back** key. NO change in setting is allowed here. To exit this mode, press **Reset** key.

V ANNUNCIATION :

To view the annunciation parameter, enter the '**V ANNUNCIATION**' mode in programming main menu by pressing **Enter** key.

This mode is not password protected. In this mode, user can only view the setting of annunciation parameter by pressing **Next** key & **Back** key. NO change in setting is allowed here. To exit this mode, press **Reset** key.

V COMM SETTING :

To view the communication parameter, enter the '**V COMM SETTING**' mode in programming main menu by pressing **Enter** key.

This mode is not password protected. In this mode, user can only view the setting of communication parameter by pressing **Next** key & **Back** key. NO change in setting is allowed here. To exit this mode, press **Reset** key.

V HISTORY :

To view the fault history, enter the '**V HISTORY**' mode in programming main menu by pressing **Enter** key.

COP-N keeps a log of last 32 faults. In this mode, user can only view the record of last 32 faults with date and time stamp. Tripping records are updated on first in first out basis. To exit this mode, press **Reset** key.

V EVENT :

To view the display event, enter the '**V EVENT**' mode in programming main menu by pressing **Enter** key.

COP-N keeps a log of last 32 events. Setting change, password modified & RTC modified are considered as event. In this mode, user can only view the record of last 32 events with date and time stamp. Event records are updated on first in first out basis. To exit this mode, press **Reset** key.

11.0 Connection Diagram / Terminal arrangement :

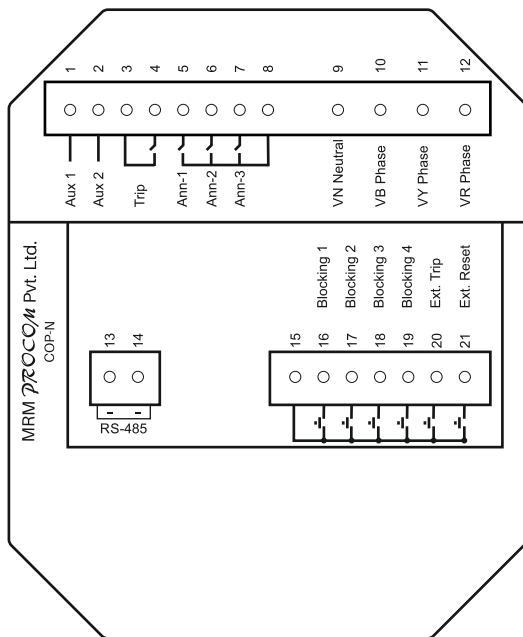

12.0 Technical specification :

Current withstand	10 times rated current
Drop Out To Pick Up Ratio	>97 %
Measurement Accuracy	
Voltage & Current	± 1%
Frequency	± 0. 05 Hz.
Power	± 1%
Surge 1.2/50Usec	2.5KV
Returning Time	30 ms
Time Lag Error Class Index E	±10 ms
Minimum Operating Time	30 ms
Transient Overreach At instantaneous Operation	<5%
Auxiliary voltage	60-300VDC & 50-300VAC
Cut out Dimensions	105mm X 125mm
Depth	90mm

13.0 Dimensional Details :

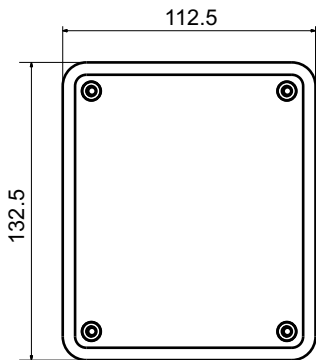

Front view

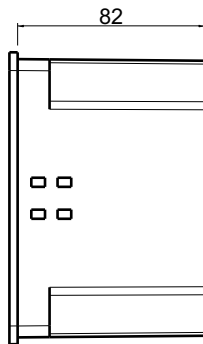

Right view

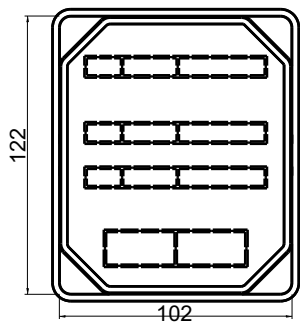

Back View

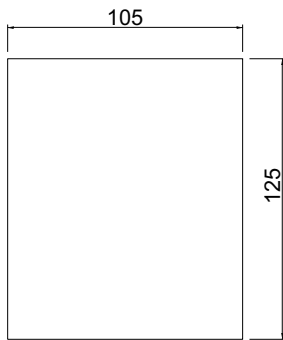

Cut Out

MRM **PROCOM**[®] Pvt. Ltd.
Plot No. 20-21, Industrial Estate
Sector-59 (II), HUDA, Faridabad-121004, Haryana
Phone: 0129-4700400 (10 Lines), E-mail : info@mrmprocom.com
Website : www.mrmprocom.com